

T5171

TIP, 2.5" IN, 3.5" OD DUAL OUT, T304

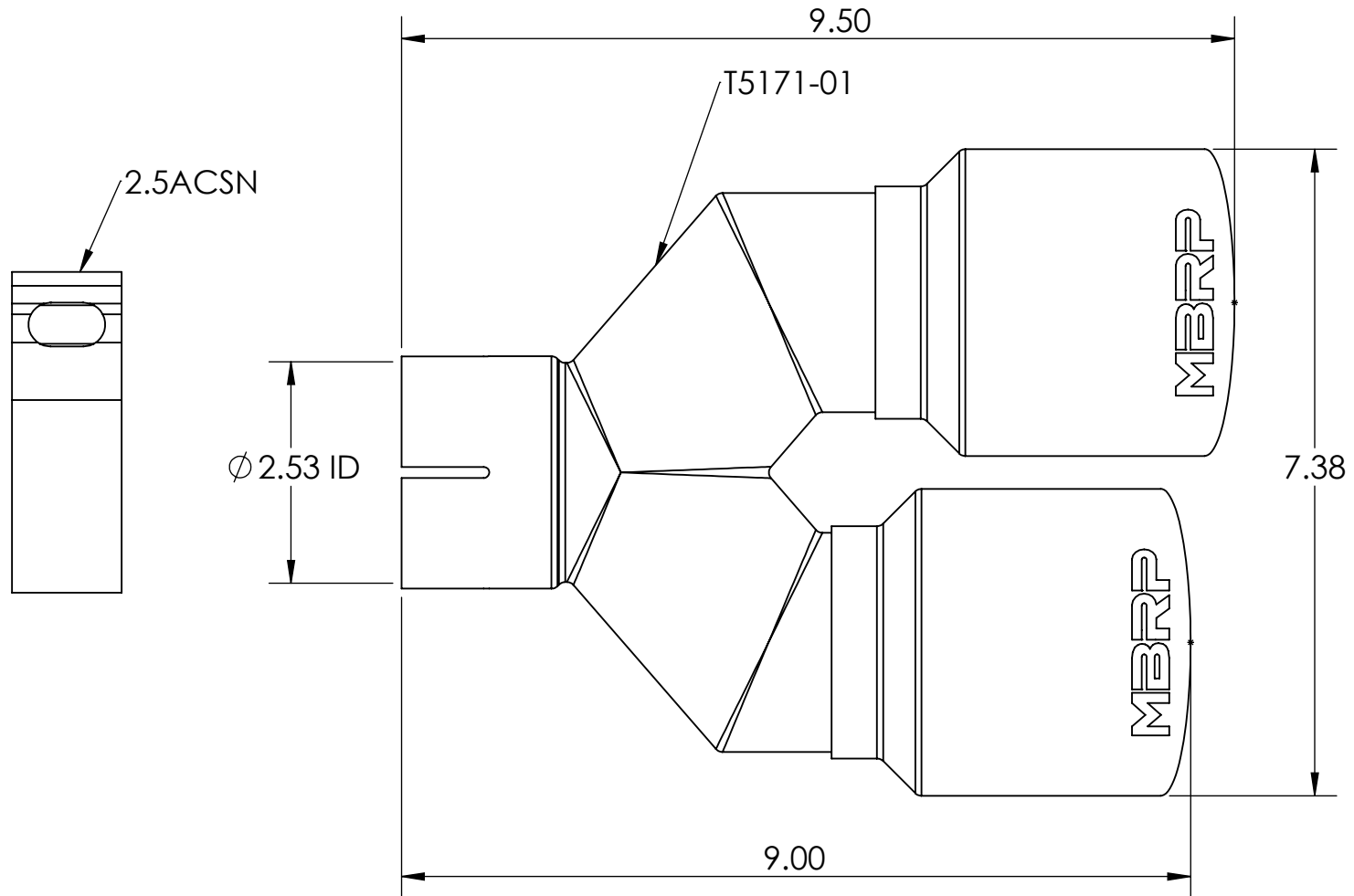

ITEM NO.	PART NUMBER	DESCRIPTION	T5171/QTY
1	T5171-01	TIP, 2.5" IN, 3.5" OD DUAL OUT, T304	1
2	2.5ACSN	CLAMP, 2.5" BAND, STAINLESS STEEL ACCUSEAL	1

26-Jun-20
REV:A

MBRP